

# GOYATAM180

Loungitude  
MOBILIER



**Montage: 10-20min**  
Assembly: 10-20min



**Outils : tournevis**  
Tools : screwdriver







**Difficulté : facile**  
Difficulty : easy

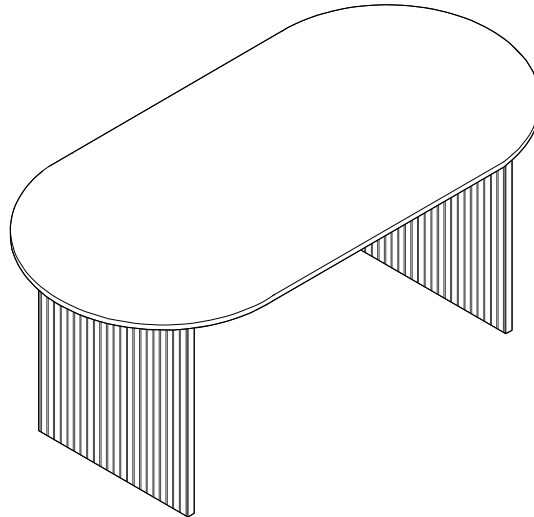





**2 personnes**  
2 people



## FRANÇAIS

-  **Attention !** Ce produit doit être monté par un adulte. Maintenir les enfants hors de la zone de montage. Laisser les sacs plastiques hors de portée. Les petites pièces présentent un risque de suffocation.
-  Préserver la notice et l'étiquette comportant le numéro de lot. Le numéro de lot est indispensable en cas de réclamation. Merci de conserver également les emballages et cartons durant la période de rétractation.
-  Pour tout commentaire ou suggestion sur ce produit, sur les instructions de montage ou nos services, s'adresser directement soit au point de vente le plus proche, soit contacter notre service client.
-  Emballages en carton recyclable. Notice en papier recyclable. Merci de ne pas jeter cette notice sur la voie publique.

## ENGLISH

-  **Warning !** This product must be mounted by an adult. Keep children out of the mounting area. Keep plastic bags out of reach. Small components present a risk of suffocation.
-  Keep the label with the lot number on it. The lot number is essential in case of a complaint. Please also keep the packaging and cartons during the withdrawal period.
-  If you have any comments or suggestions about this product, the assembly instructions or our services, please contact us directly at the nearest point of sale or our customer service.
-  Recyclable cardboard packaging. Recyclable paper leaflet. Please do not throw this leaflet on the street.

n° 1	1800x900x25 mm	x 1
n° 2	1210x200x25 mm	x 2
n° 3	200x199x25 mm	x 2
n° 4	725x600x24 mm	x 2

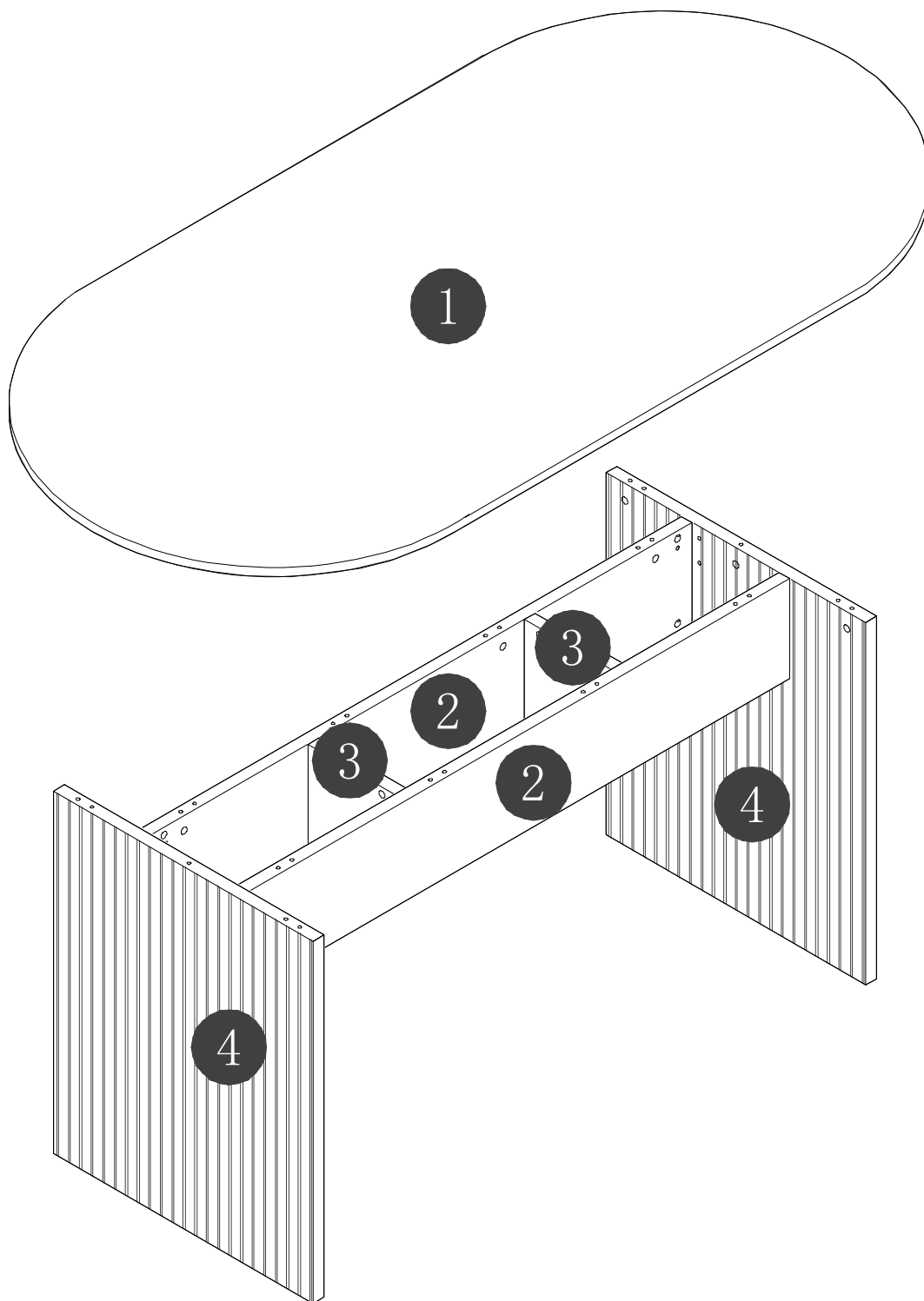



A=32

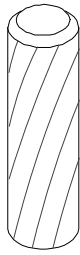

B=28

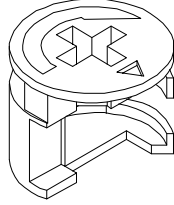

C=32



D=32

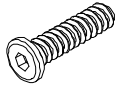

M6\*20

G=20

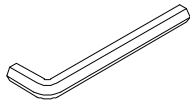

H=1

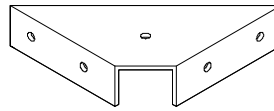

Y=4



Z1=20

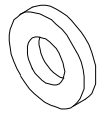

Z2=20

( 1 )

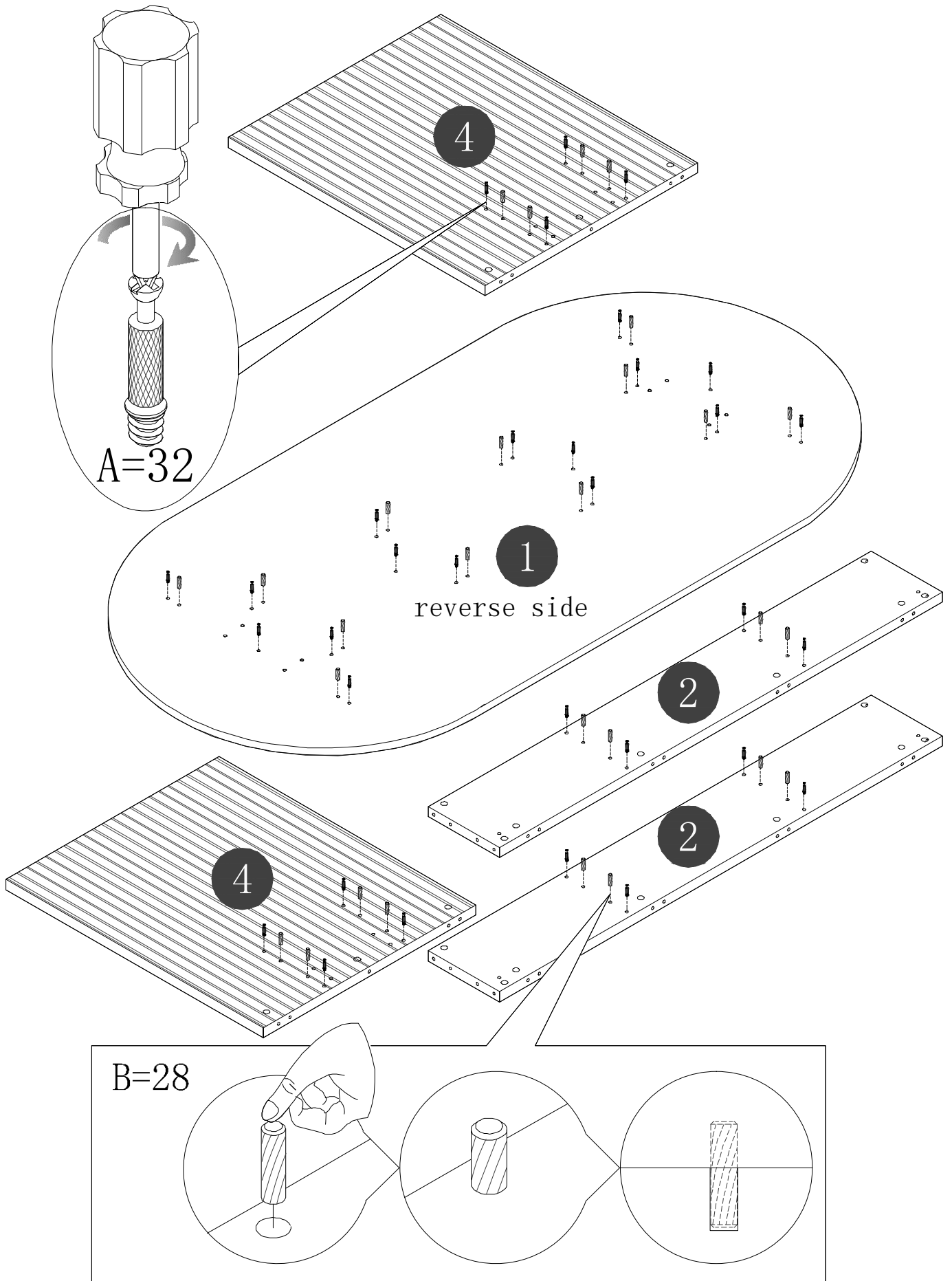

( 2 )

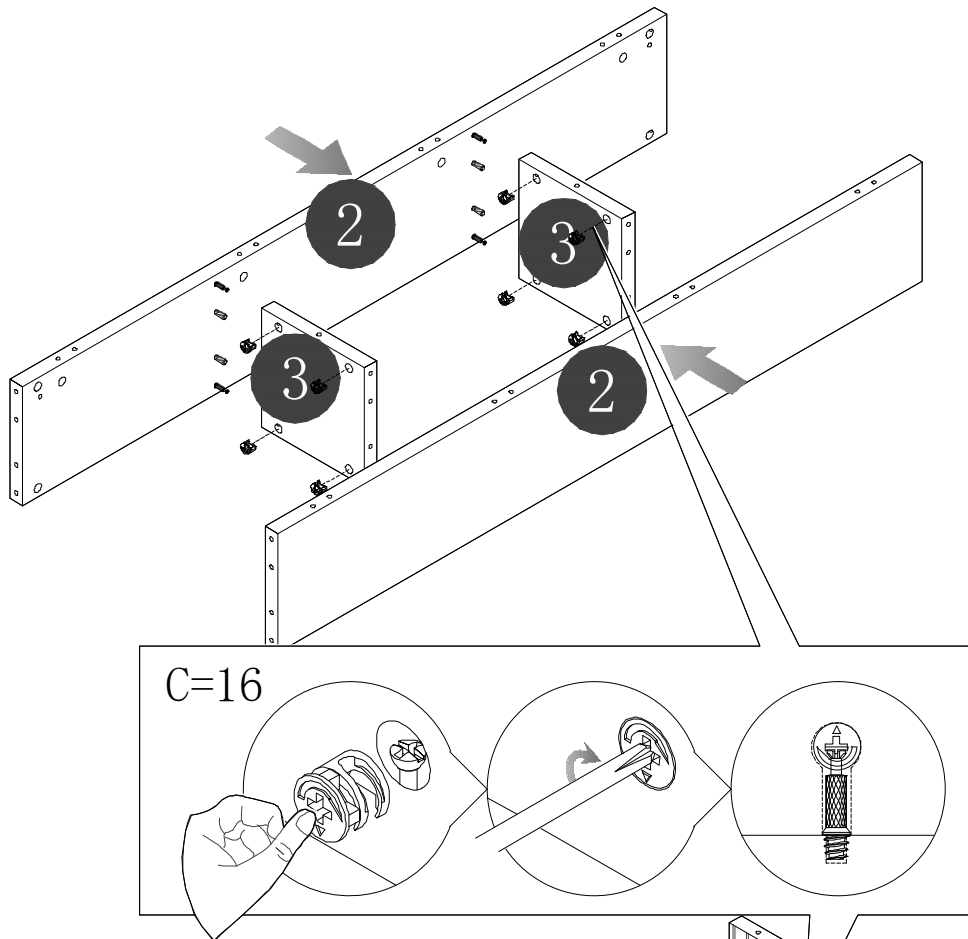

( 3 )

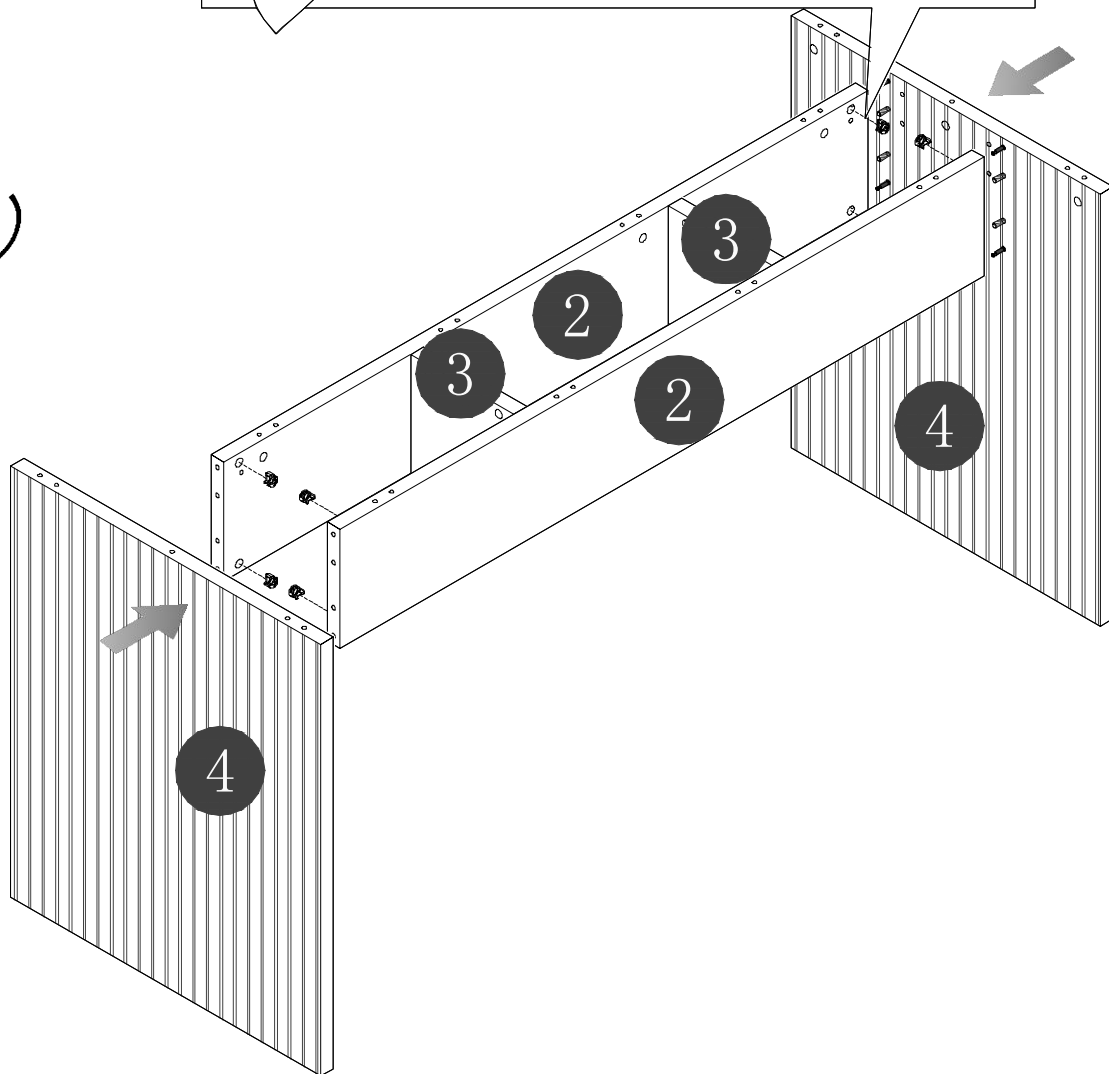

( 4 )

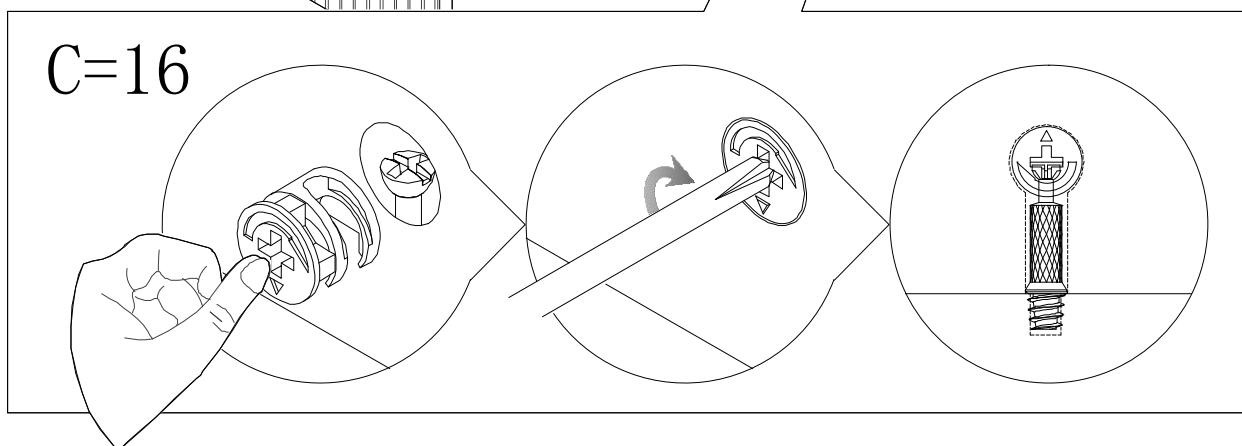
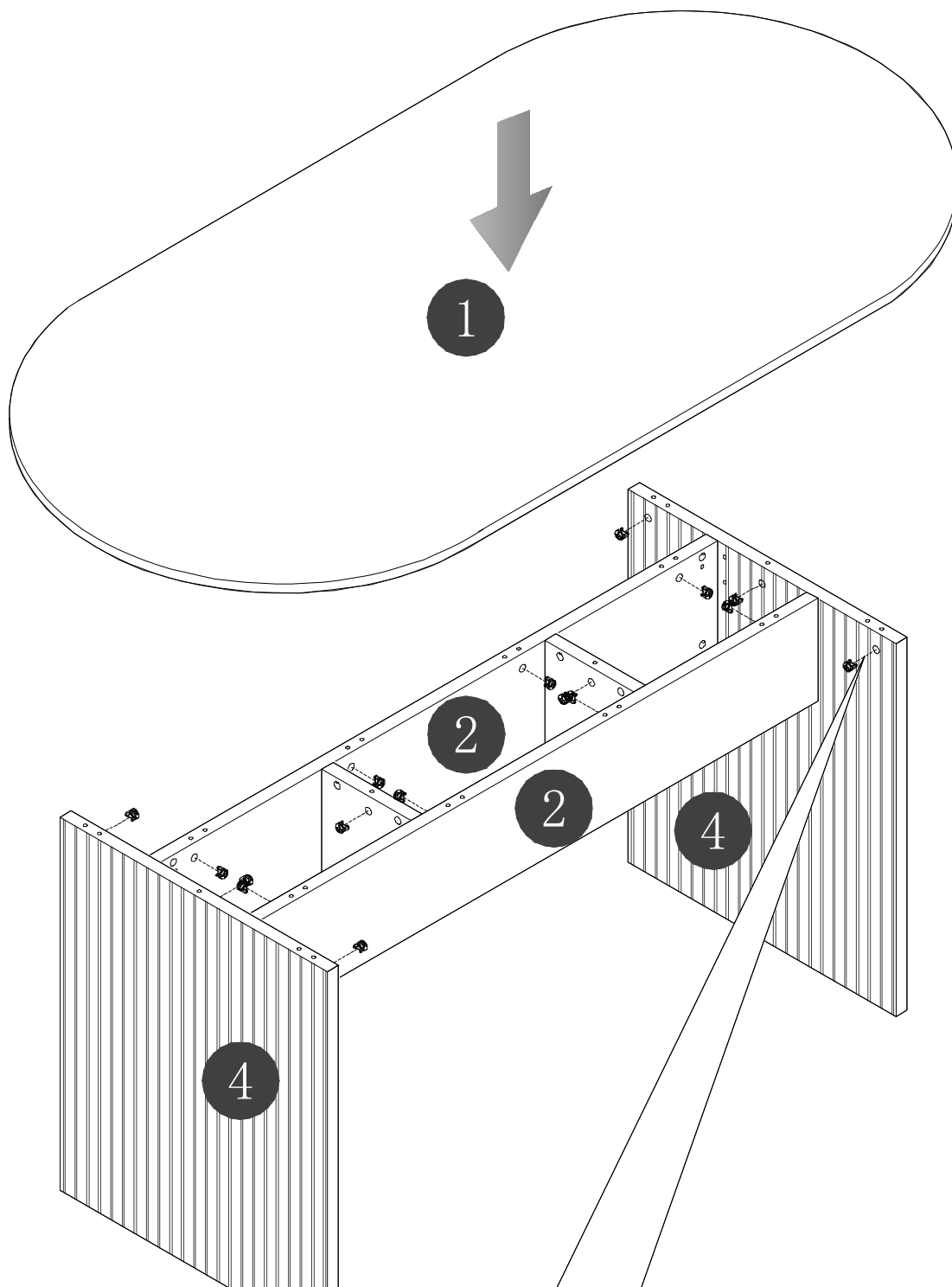

( 5 )

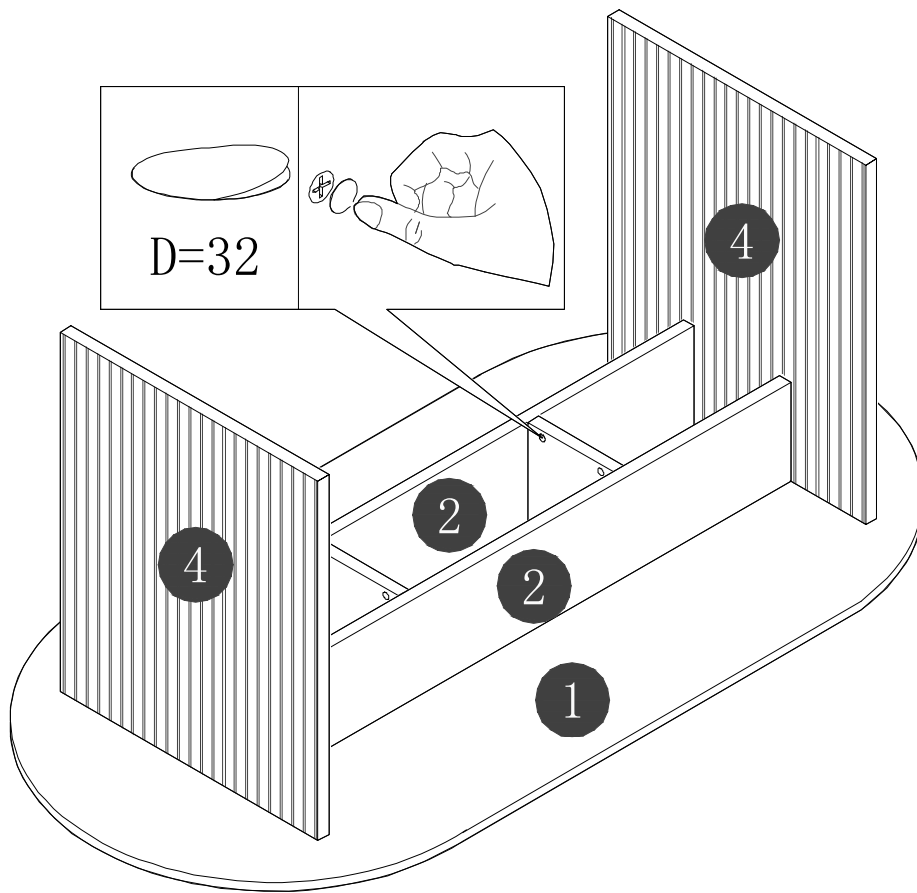

( 6 )

