



Montage : 60 min
Assembly : 60 min



Outils : inclus
Tools : included







Difficulté : facile
Difficulty : easy

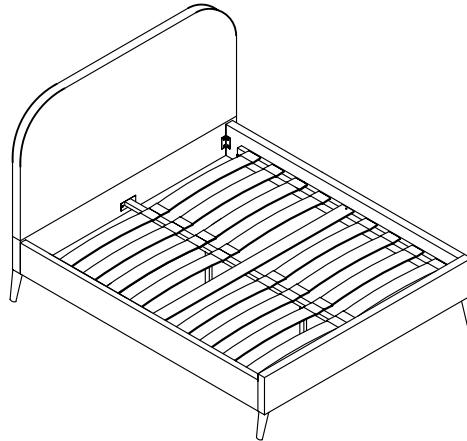





2 personnes
2 people



FRANÇAIS

-  **Attention !** Ce produit doit être monté par un adulte. Maintenir les enfants hors de la zone de montage. Laisser les sacs plastiques hors de portée. Les petites pièces présentent un risque de suffocation.
-  Préserver la notice et l'étiquette comportant le numéro de lot. Le numéro de lot est indispensable en cas de réclamation. Merci de conserver également les emballages et cartons durant la période de rétractation.
-  Pour tout commentaire ou suggestion sur ce produit, sur les instructions de montage ou nos services, s'adresser directement soit au point de vente le plus proche, soit contacter notre service client.
-  Emballages en carton recyclable. Notice en papier recyclable. Merci de ne pas jeter cette notice sur la voie publique.

ENGLISH

-  **Warning !** This product must be mounted by an adult. Keep children out of the mounting area. Keep plastic bags out of reach. Small components present a risk of suffocation.
-  Keep the label with the lot number on it. The lot number is essential in case of a complaint. Please also keep the packaging and cartons during the withdrawal period.
-  If you have any comments or suggestions about this product, the assembly instructions or our services, please contact us directly at the nearest point of sale or our customer service.
-  Recyclable cardboard packaging. Recyclable paper leaflet. Please do not throw this leaflet on the street.

FRANÇAIS

Pour garantir une totale satisfaction, nous vous recommandons de lire attentivement cette notice avant toute utilisation. Elle contient des informations importantes qu'il convient de conserver.

Conseils de montage

Avant de commencer le montage, identifier les différentes pièces à l'aide de la notice. Vérifier qu'aucune pièce n'est manquante. Si une pièce manque, contacter notre service client. Afin de ne pas égarer de pièces, merci de ne pas jeter le carton avant d'avoir terminé le montage complet. Munissez-vous de l'outillage nécessaire (si non inclus). Pour éviter que le produit ne soit griffé ou abimé, assembler votre produit au sol sur une surface plane et propre (par exemple sur une couverture). Planifier de monter votre produit aussi près que possible de l'endroit où il sera installé. **Pour le mobilier à fixer au mur, merci de vérifier régulièrement les vis. Le produit peut se renverser ou causer une chute. Toutes négligences pourraient être source d'accidents. Ne jamais forcer le montage.**

Conseils d'utilisation et instructions de sécurité importantes

Produit destiné à un usage domestique, il doit être utilisé à l'intérieur uniquement. Ne pas placer près d'une source de chaleur trop intense (radiateur, cheminée), ni d'une source d'humidité. Afin de ne pas endommager le revêtement, il est recommandé de ne pas déposer d'objet chaud ou humide directement sur sa surface. Les premiers jours après l'installation du produit, il est conseillé d'aérer fréquemment la pièce. Pour les produits comportant les composants électroniques : vérifier régulièrement le câble, le transformateur et toutes les pièces pour vous assurer qu'ils ne sont pas endommagés. Ne pas utiliser le produit si une pièce est endommagée.

Conseils d'entretien

Dépoussiérer régulièrement avec un chiffon sec. Entretien avec des mouvements dans le sens des fibres. Éponger immédiatement les liquides renversés à l'aide d'un chiffon propre et sec. Nettoyer à l'aide d'un chiffon doux et humide. Essuyer ensuite avec un chiffon propre et sec. Ne pas utiliser de matières et produits abrasifs, pouvant rayer ou abimer le revêtement.

Produit garanti deux ans. Les lattes de lit cassées ou endommagées ne sont pas prises en charge par la garantie.

ENGLISH

To guarantee total satisfaction, we recommend that you read this assembly instruction carefully before any use. This assembly instruction contains important information that should be kept.

Assembly Tips

Before starting the assembly, identify the different components using the instructions. Check that no components are missing. If a component is missing, contact our customer service. In order not to lose parts, please do not discard the cardboard until you have finished the complete assembly. Equip yourself with the necessary tools (if not included). To prevent the product from being scratched or damaged, assemble your product on the ground on a flat and clean surface (for example on a blanket). Plan to assemble your product as close as possible to where it will be installed. **For product to be fixed to the wall, please check the screws regularly. The product may spill or cause a fall. All negligence could be a source of accidents. Never force the assembly.**

Safety instructions

This product is for indoor domestic use only. Do not place near a source of heat that is too intense (radiator, chimney), or a source of moisture. In order not to damage the coating, it is recommended not to put hot or wet objects directly on it. In the first few days after installation of the product, it is advisable to ventilate the room frequently. For products with electronic components: check cables, AC/DC and plugs regularly to ensure that they are not damaged. Do not use the product if a part is damaged.









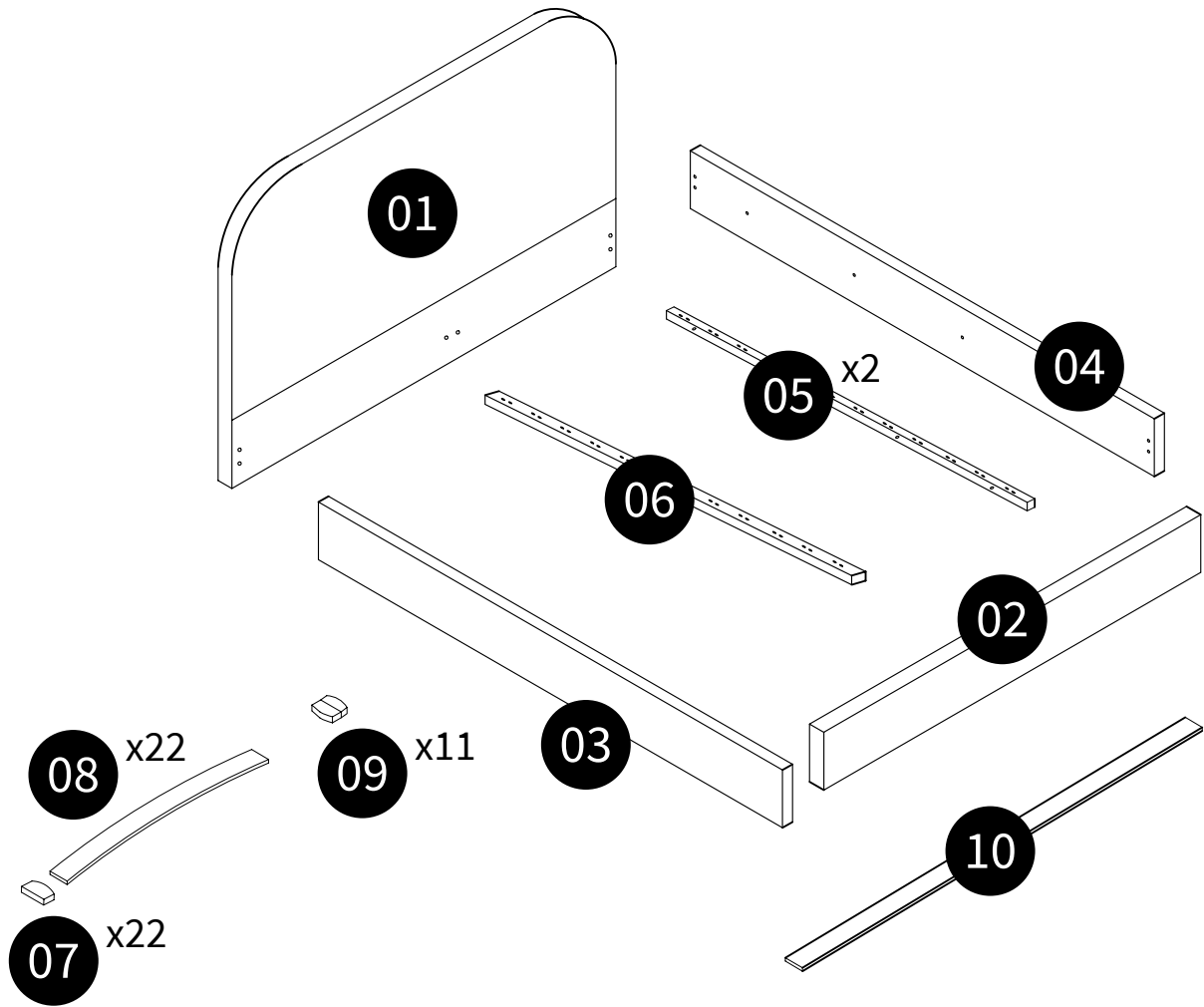



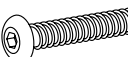

Maintenance

Dust regularly with a dry cloth. Maintain with movements in the direction of the fibers. Immediately wipe down spilled liquids with a clean, dry cloth. Clean with a soft, damp cloth. Wipe with a clean, dry cloth. Do not use abrasive materials or products that can scratch or damage the coating.

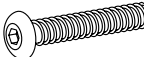
Product warranty is two years. Broken or damaged bed slats are not supported by the warranty.

Les lattes de lit cassées ou endommagées ne sont pas prises en charge par la garantie.
 All broken slats are not cover by the product warranty.



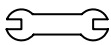



A	 8*20	20	F		2	K	 18cm	4
B	 8*40	4	G		4	L		4
C	 8*50	8	H		2	M		4
D	 8*60	4	I		2	N		1
E	 3.5*30	2	J	 23.5cm	2	O		1
						P		1

Étape 1.

Step 1.

O		1
---	---	---

M		4
L		4

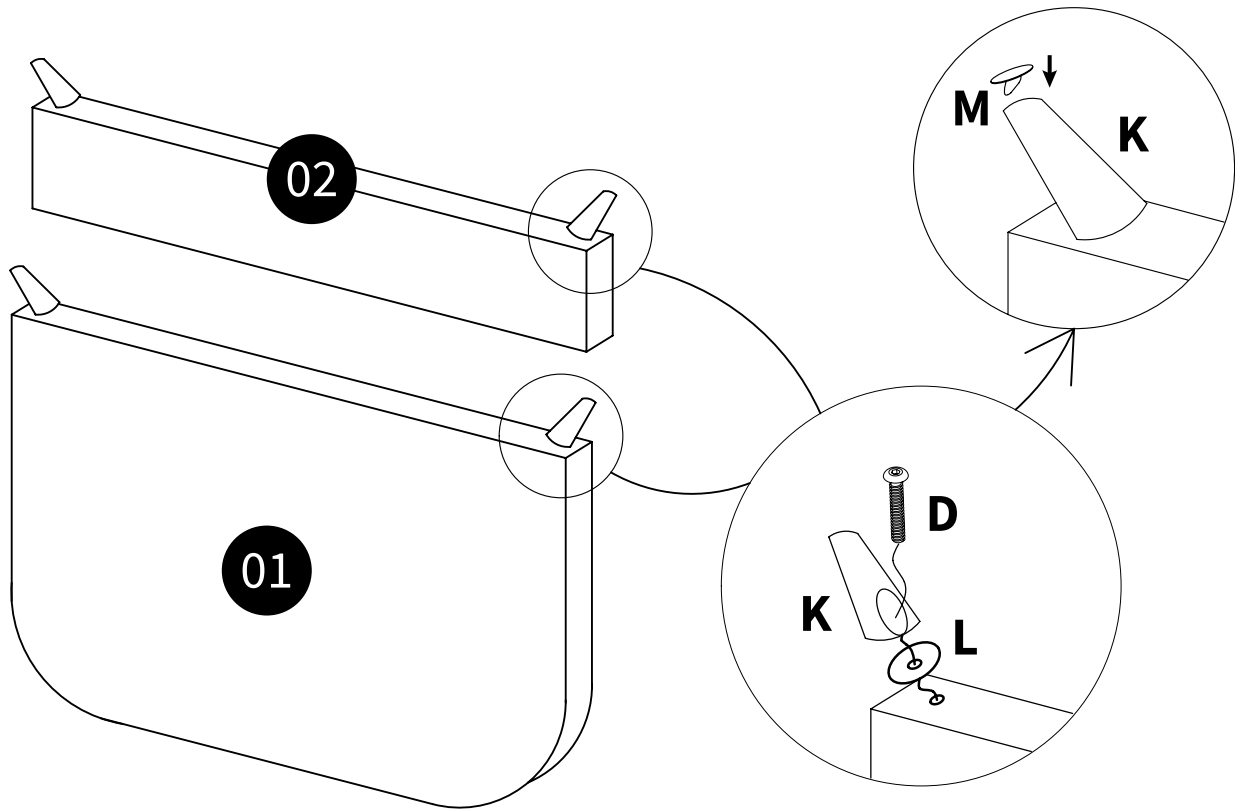

K		4
D		4



Étape 2.

Step 2.

O		1
---	---	---

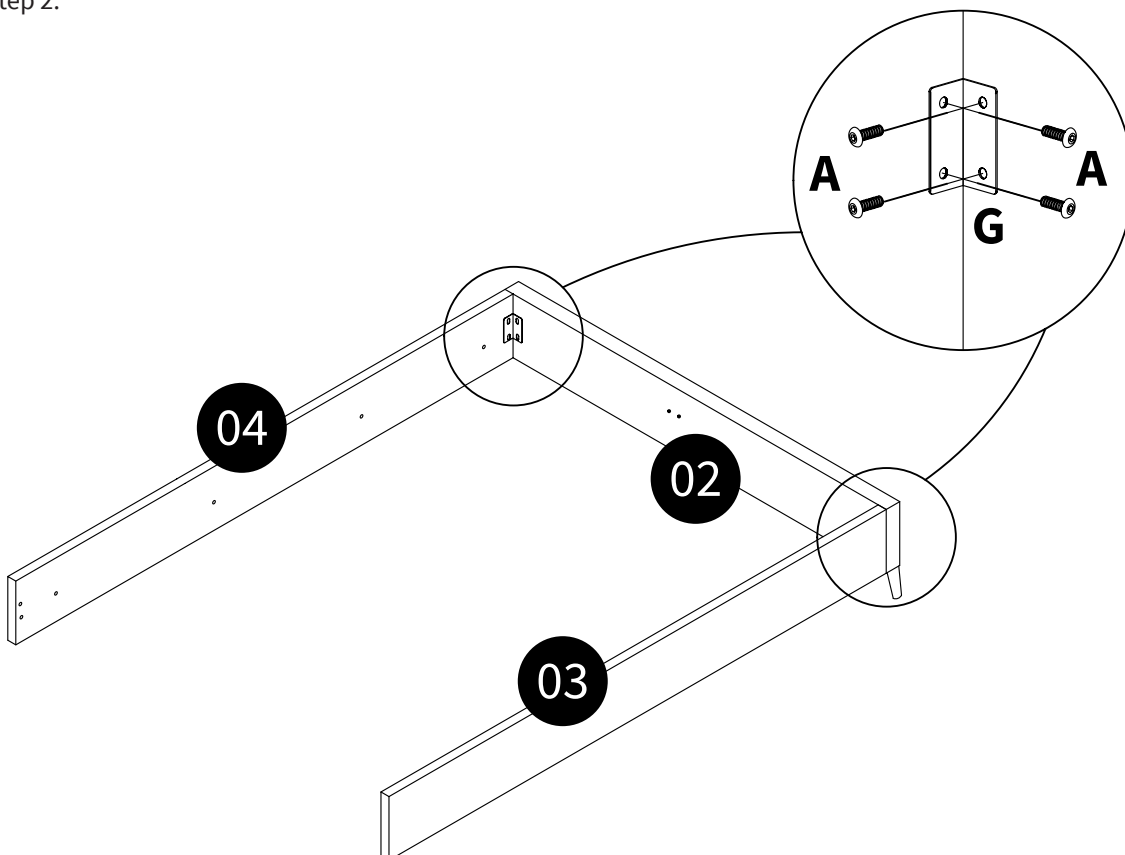

G		2
A		8





Étape 3.

Step 3.

O		1
---	---	---

M		4
L		4

K		4
D		4

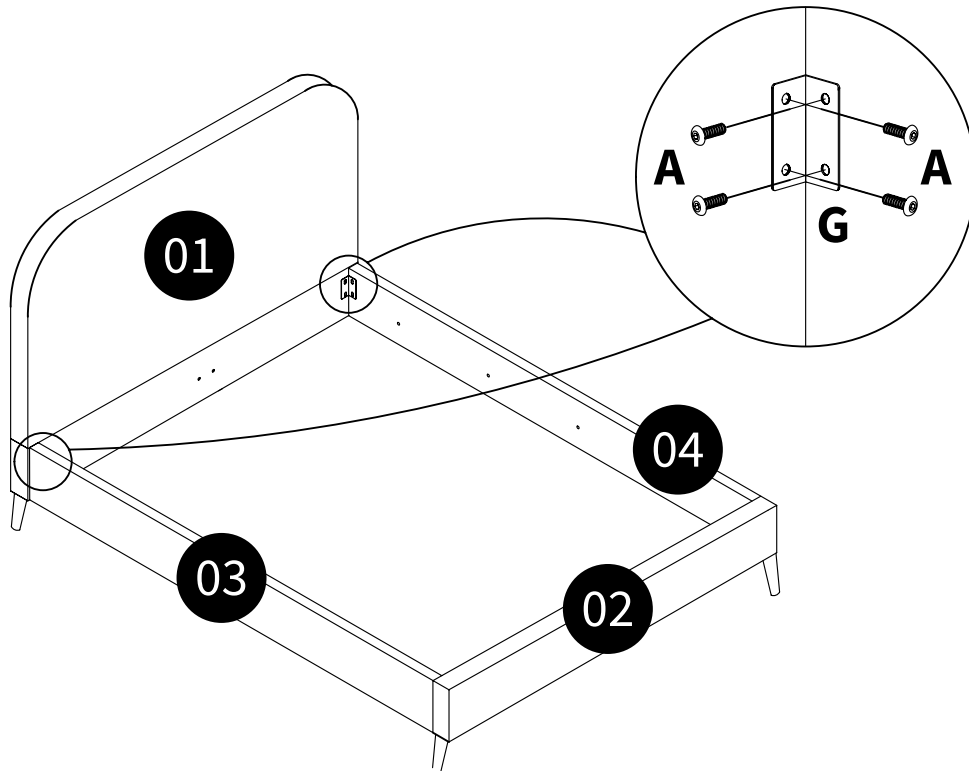

Étape 4.

Step 4.



O		1
---	---	---

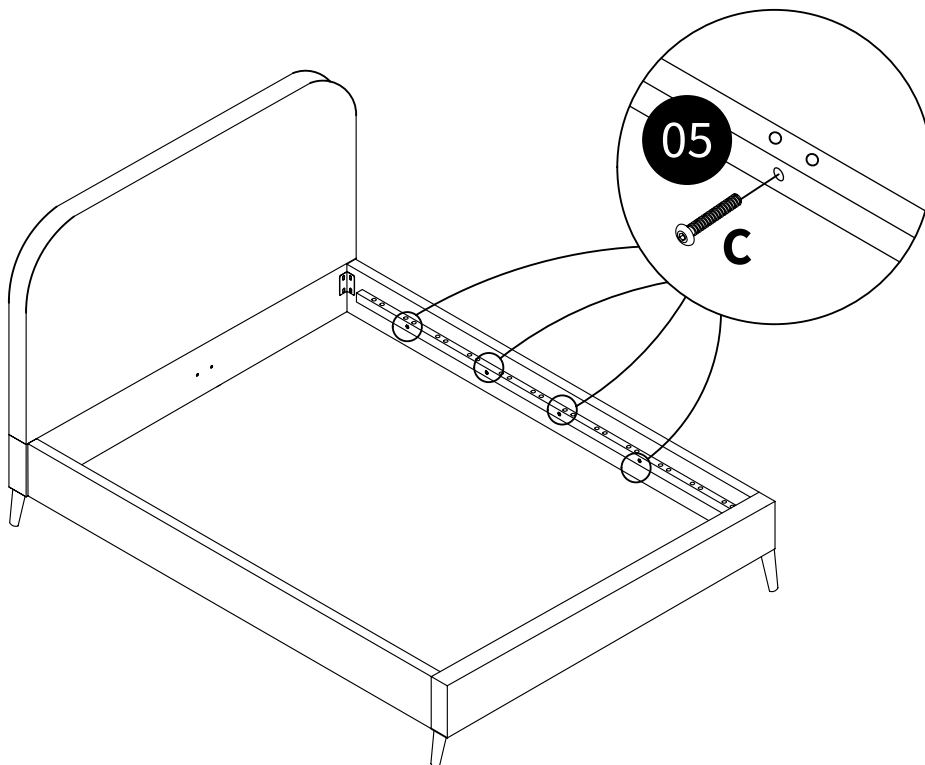

C		8
---	---	---





Étape 5.

Step 5.

P		1
O		1

J		2
F		2

I		2
H		2
B		4

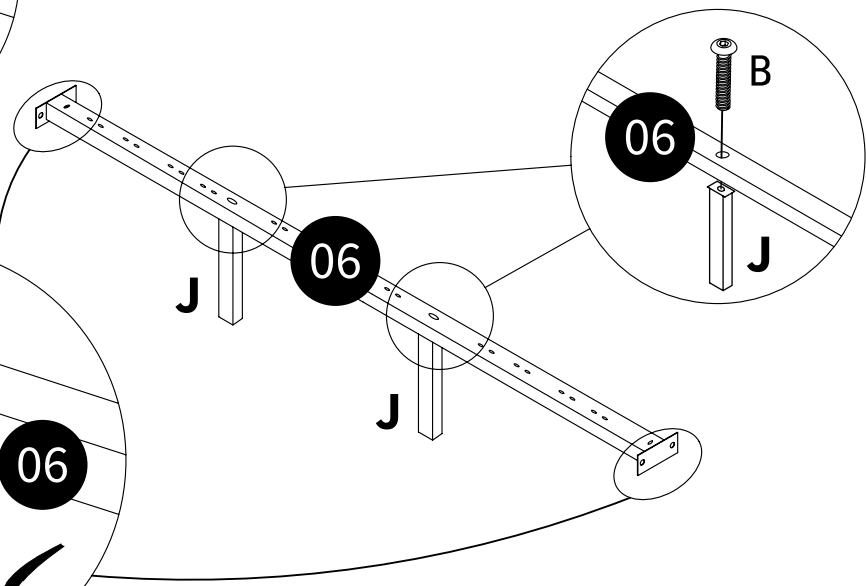
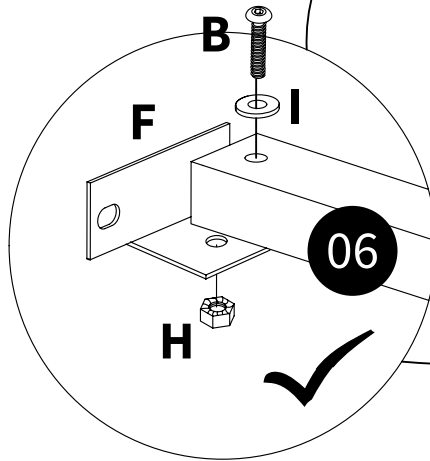
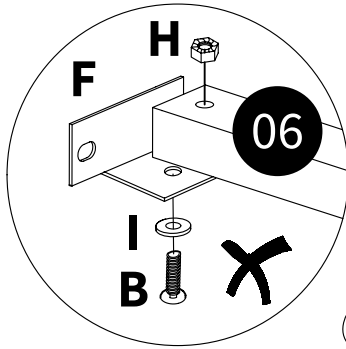

Fixez la barre centrale H au-dessus de la pièce en métal F
Fix the central bar H above the metal part F

Étape 6.

Step 6.

O		1
---	---	---

A		4
---	---	---

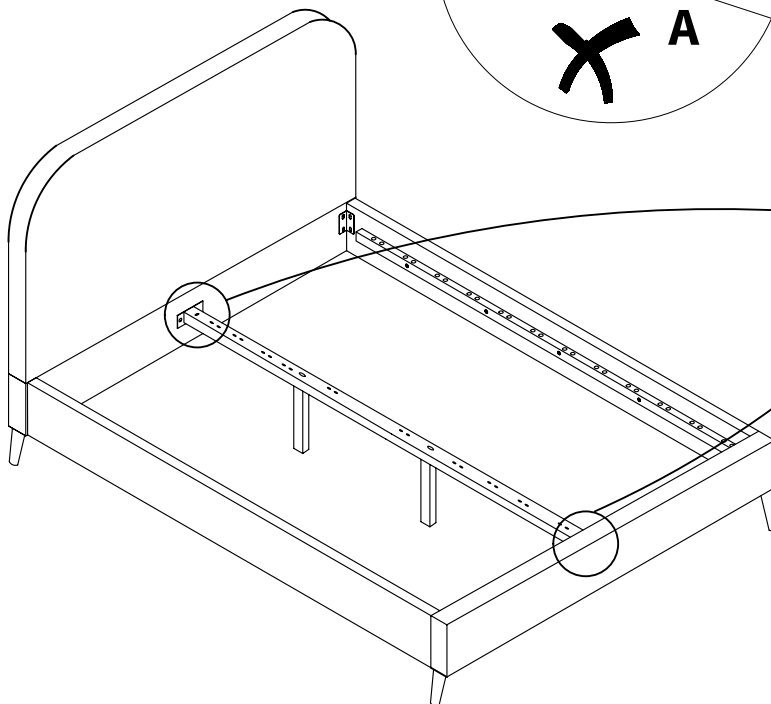
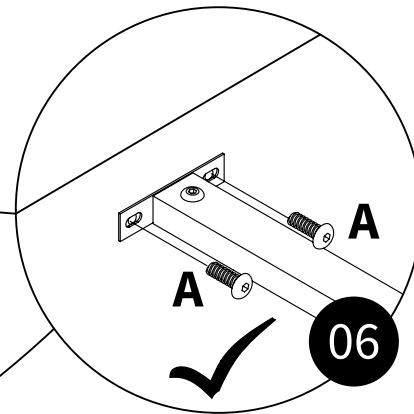
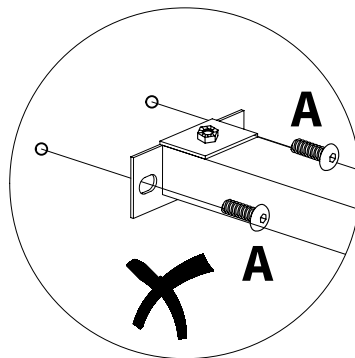

Étape 7.

Step 7.

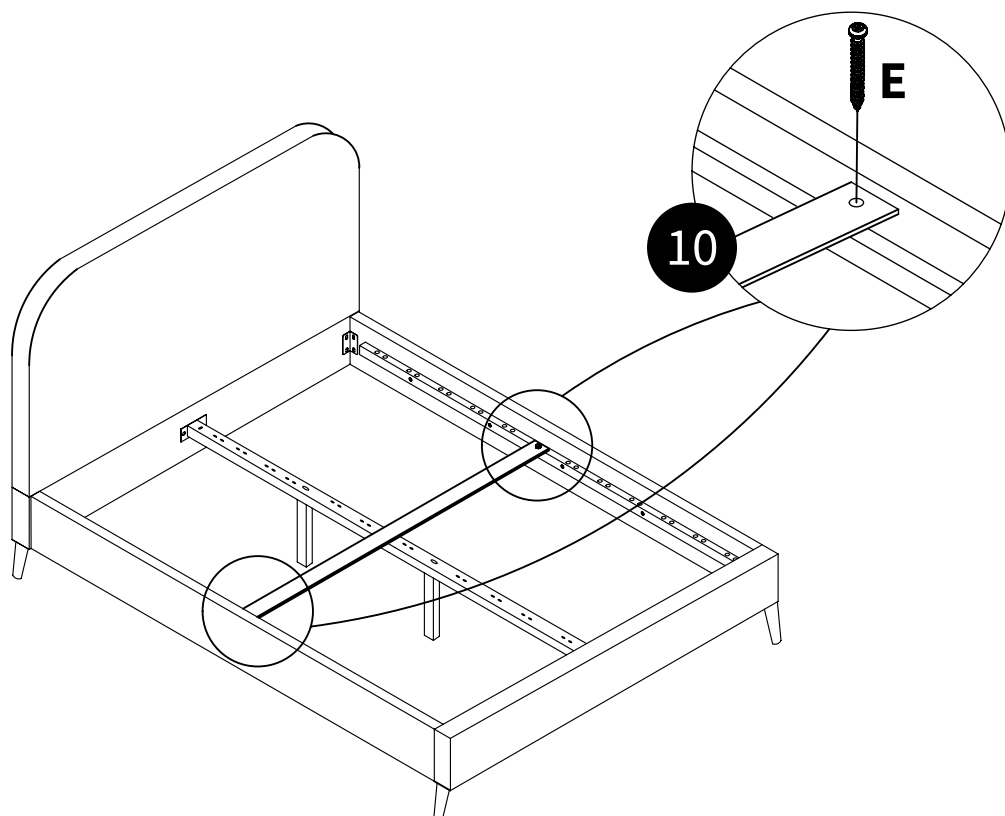

N		1	E		2
---	---	---	---	---	---

Étape 8.

Step 8.

